

Elephant

Dave Brill ©1981

use a large square, minimum 30x30 cm

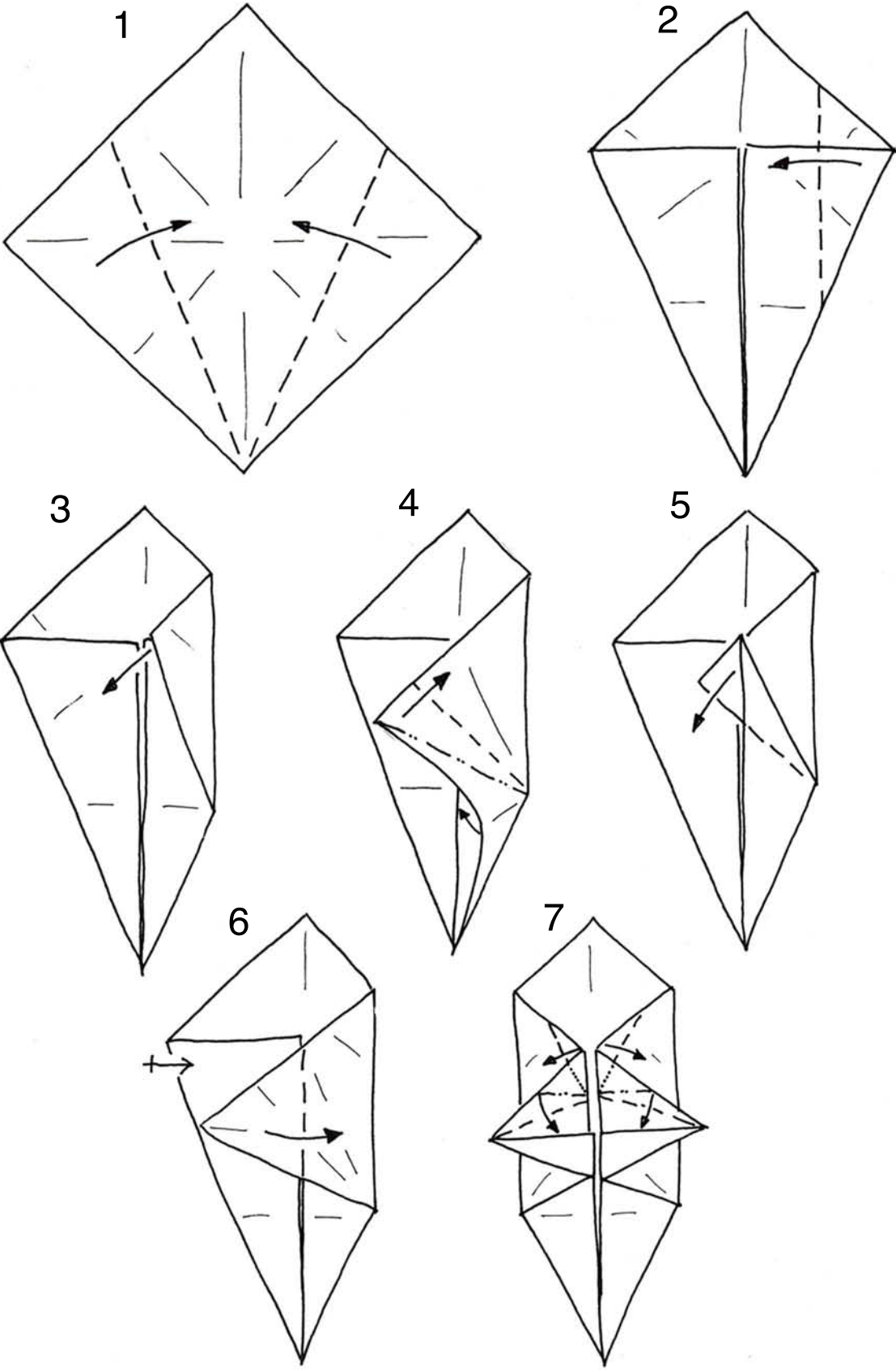

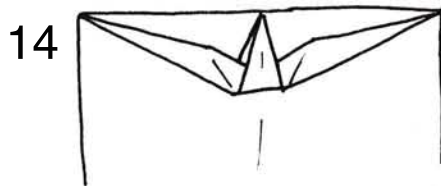
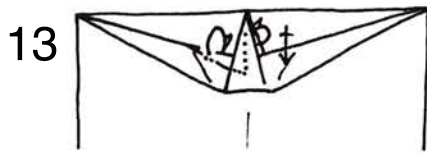
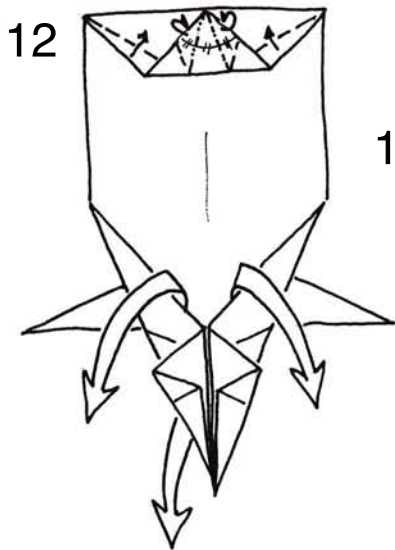
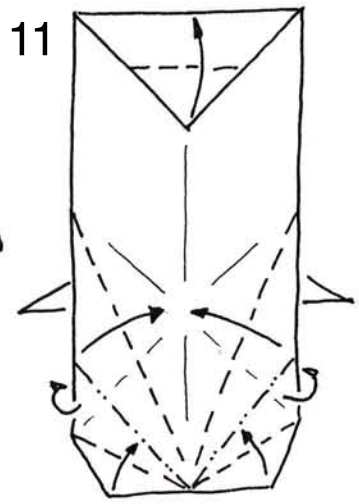
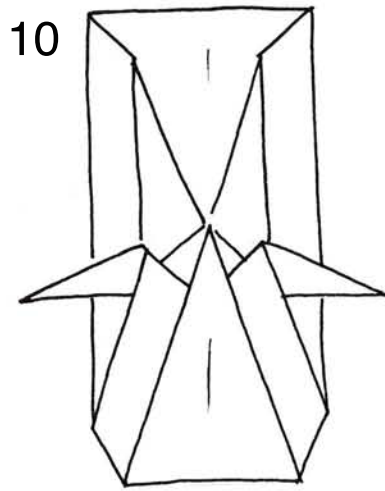
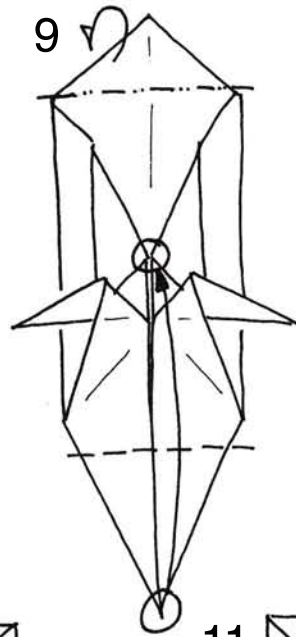
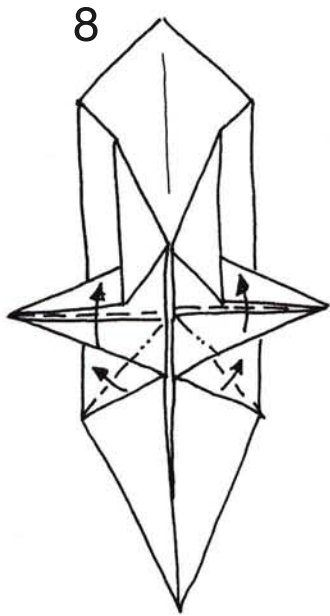

15

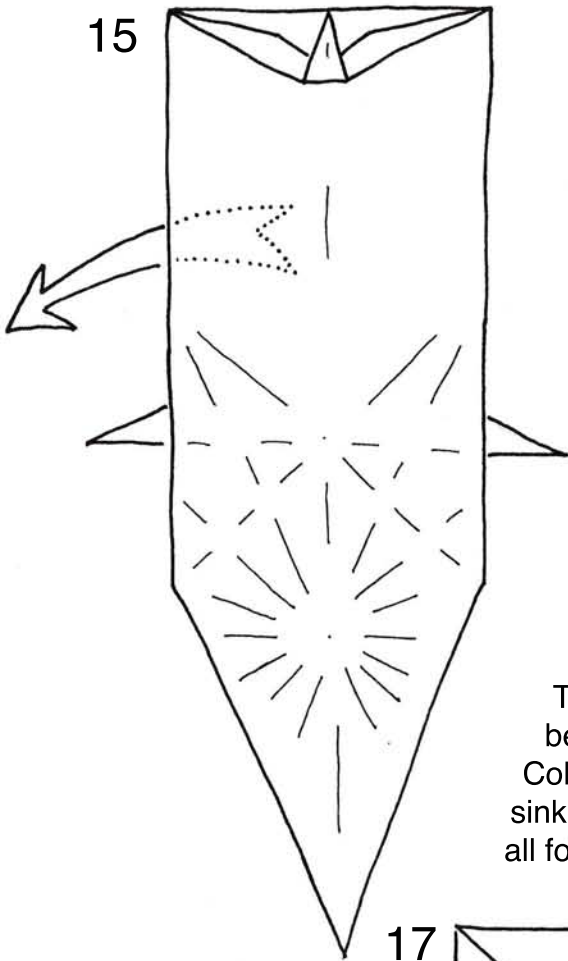

16

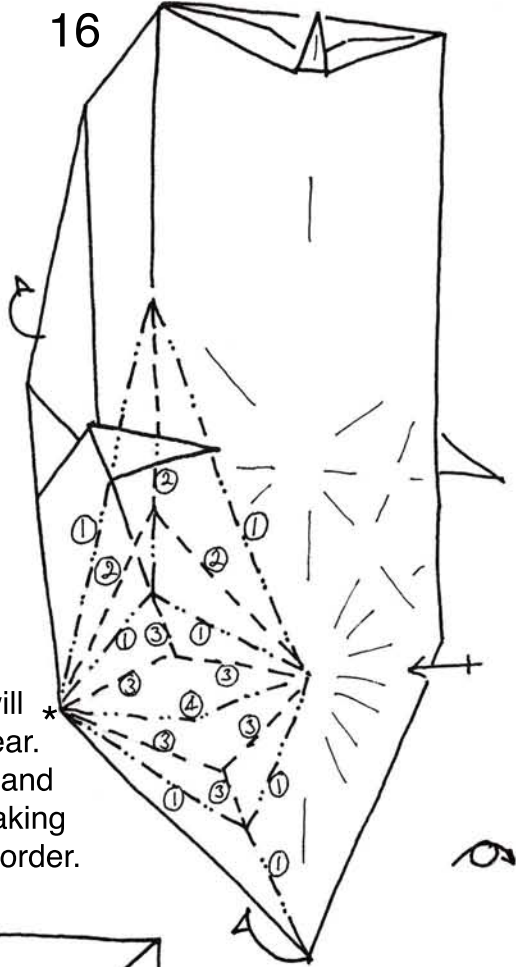

This* will *
 be the ear.
 Collapse and
 sink by making
 all folds in order.

17

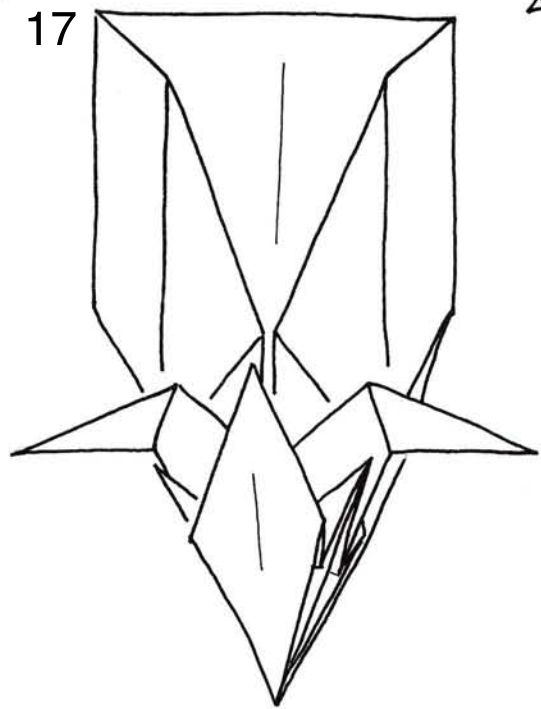

18

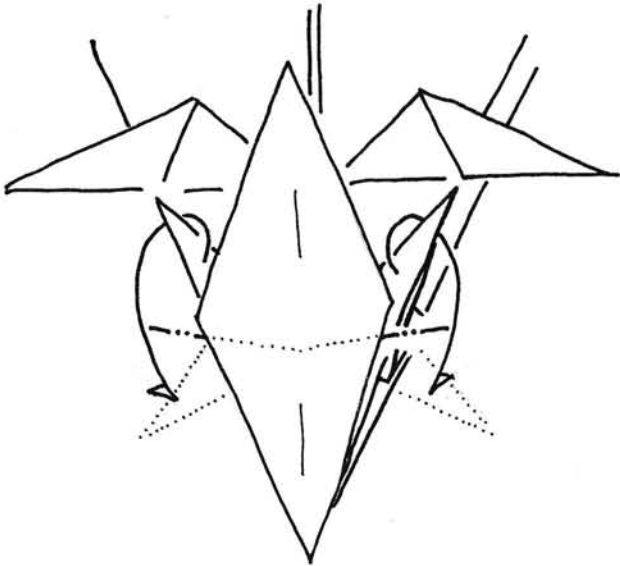

19

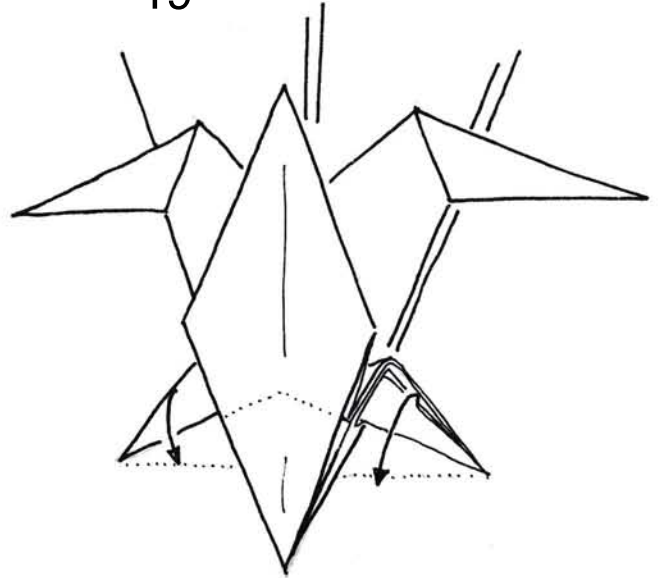

20

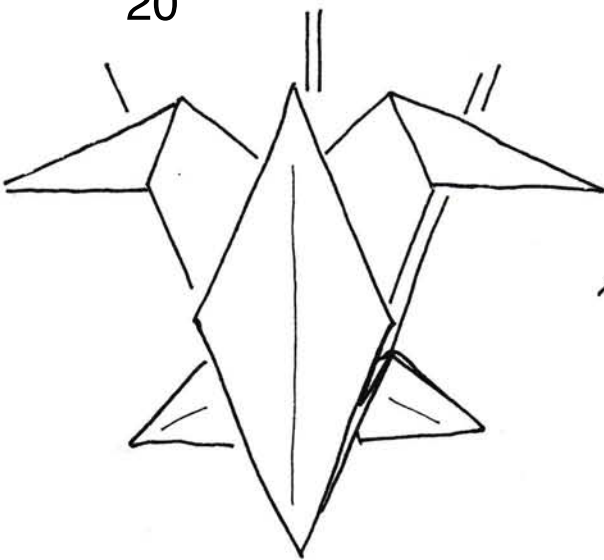

21

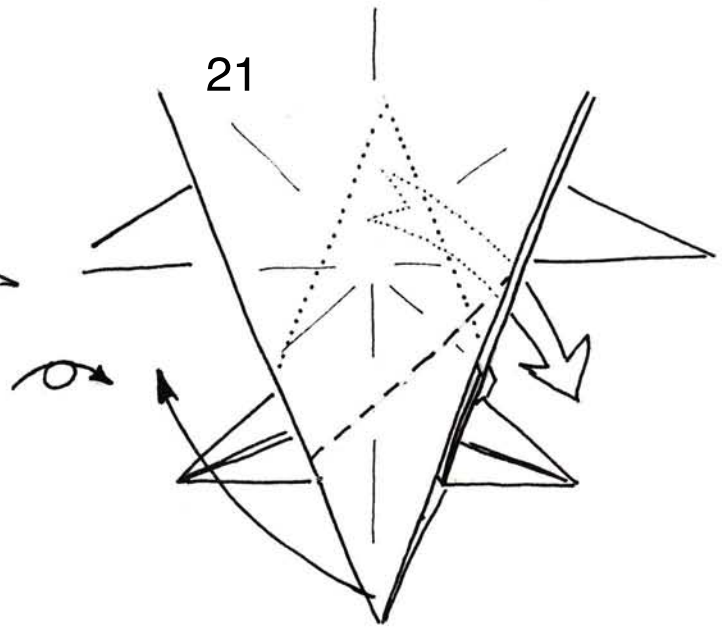

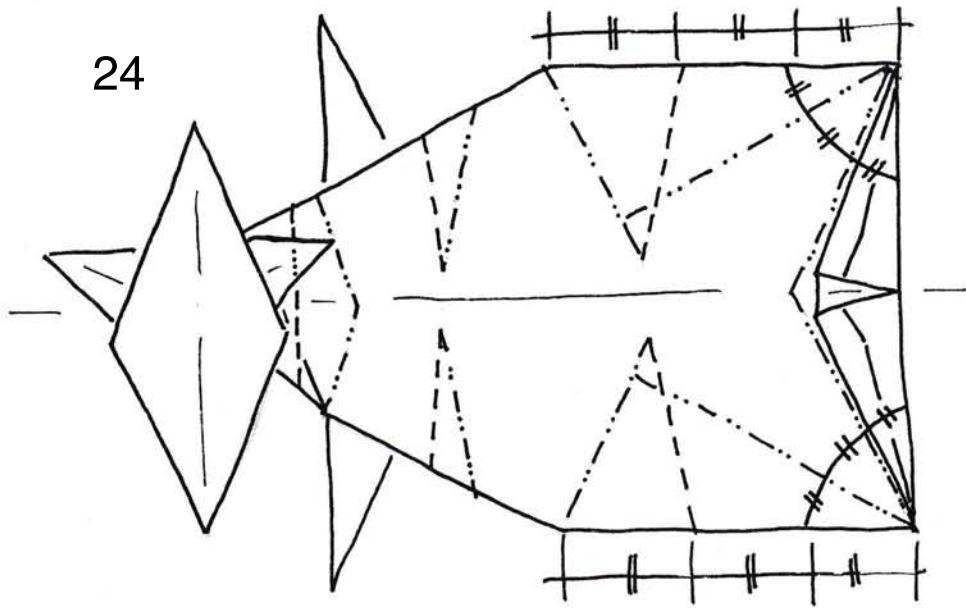
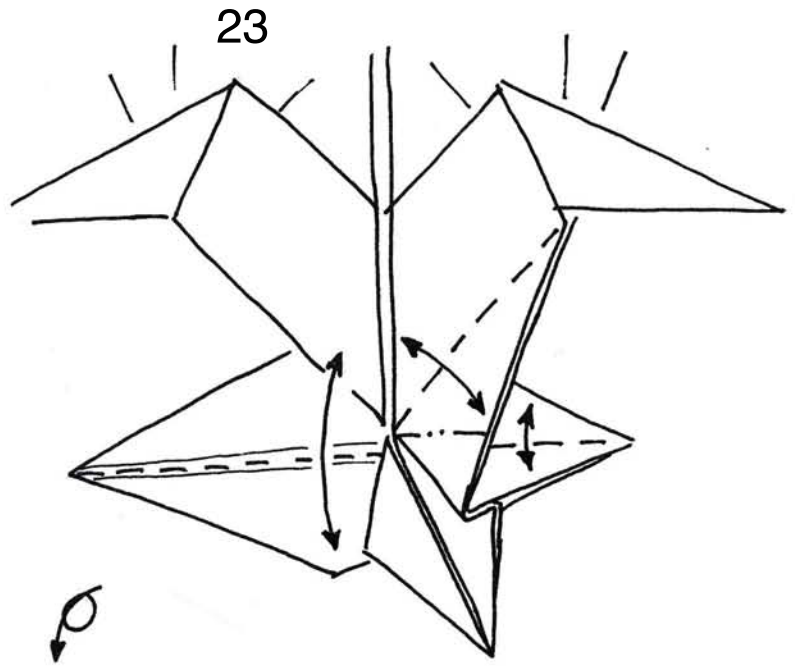
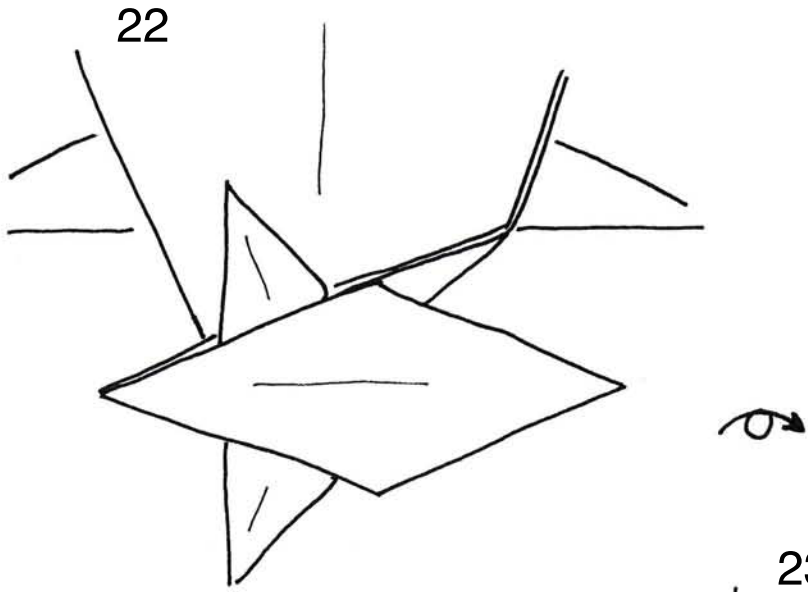

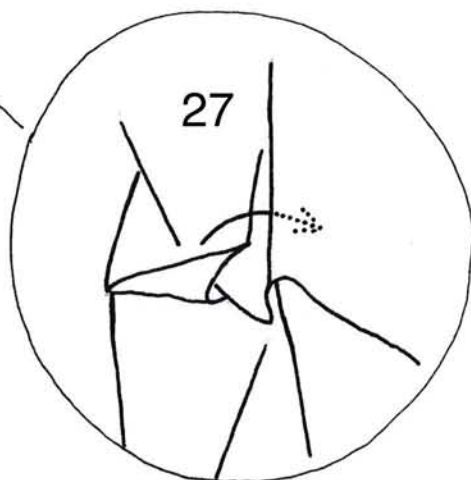
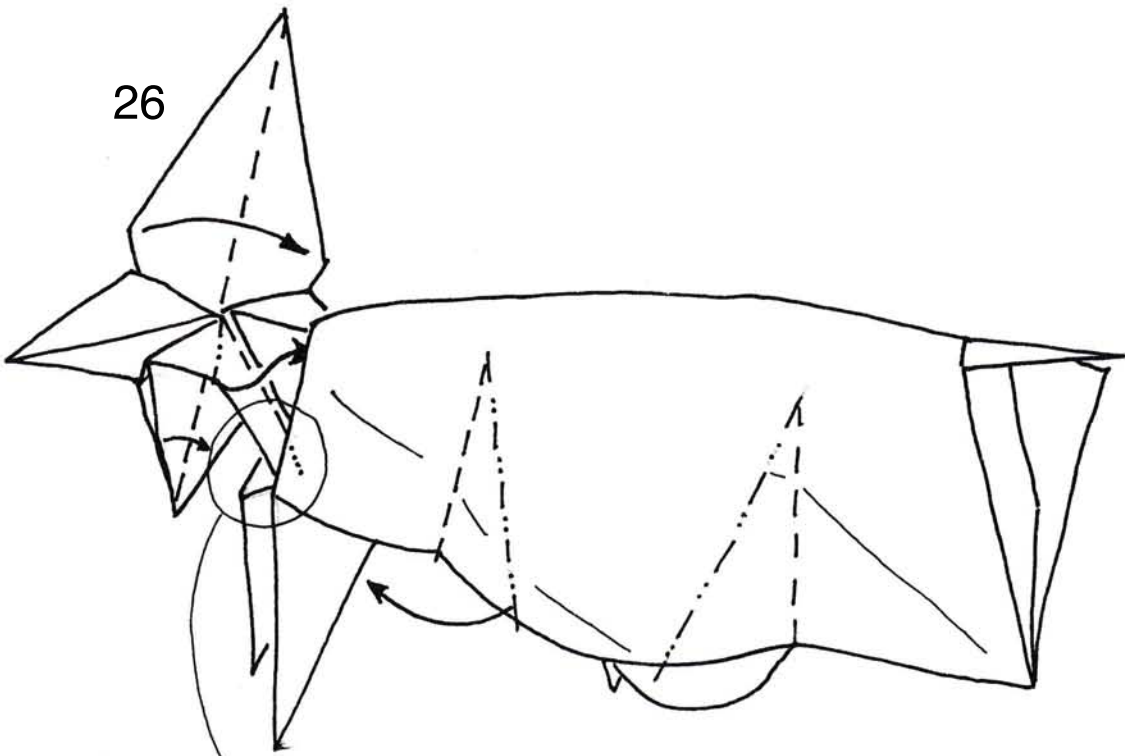
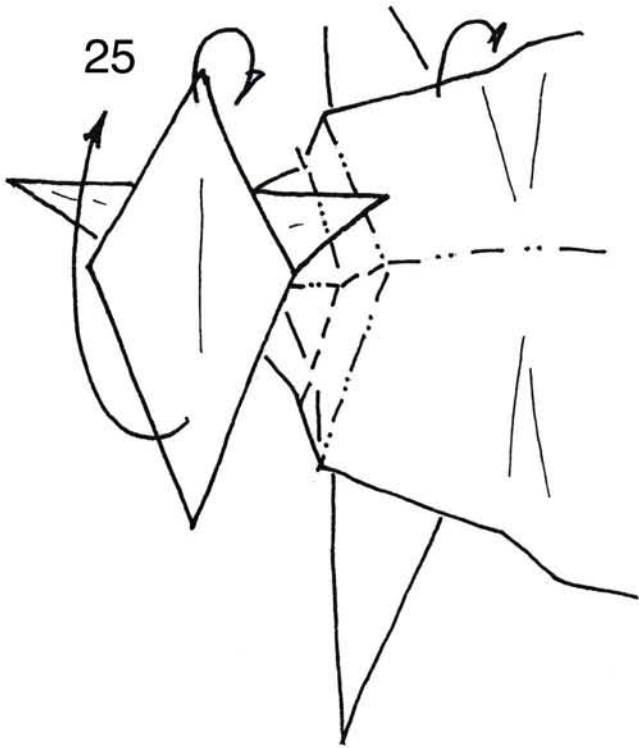

28

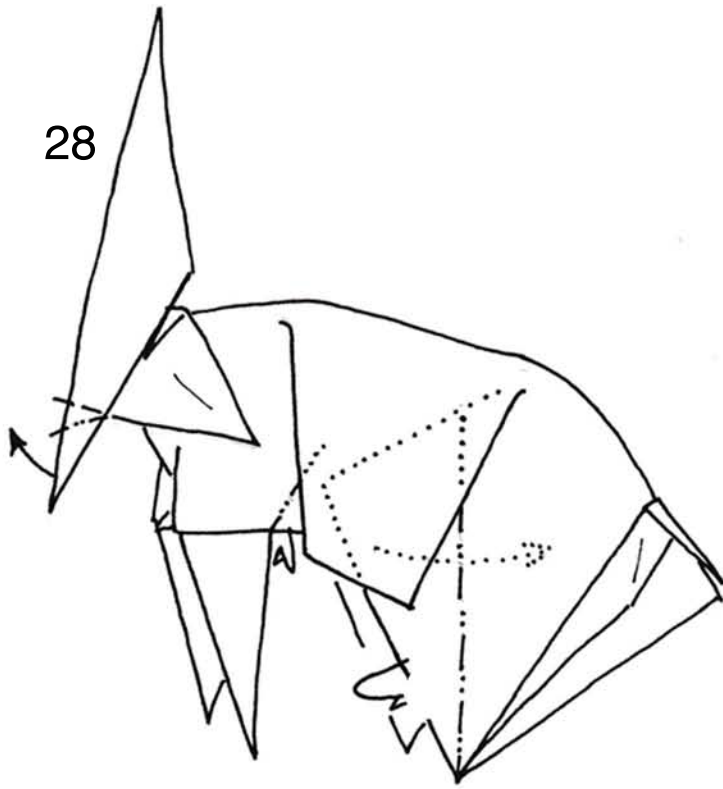

29



30

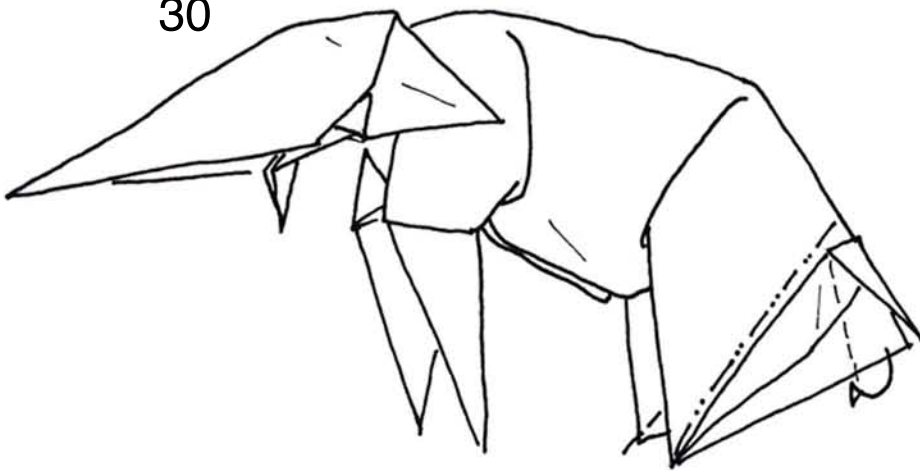

31

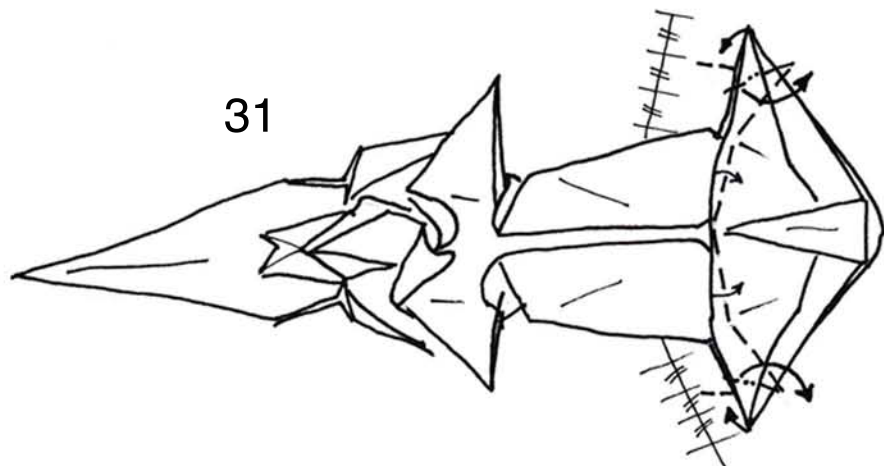

32

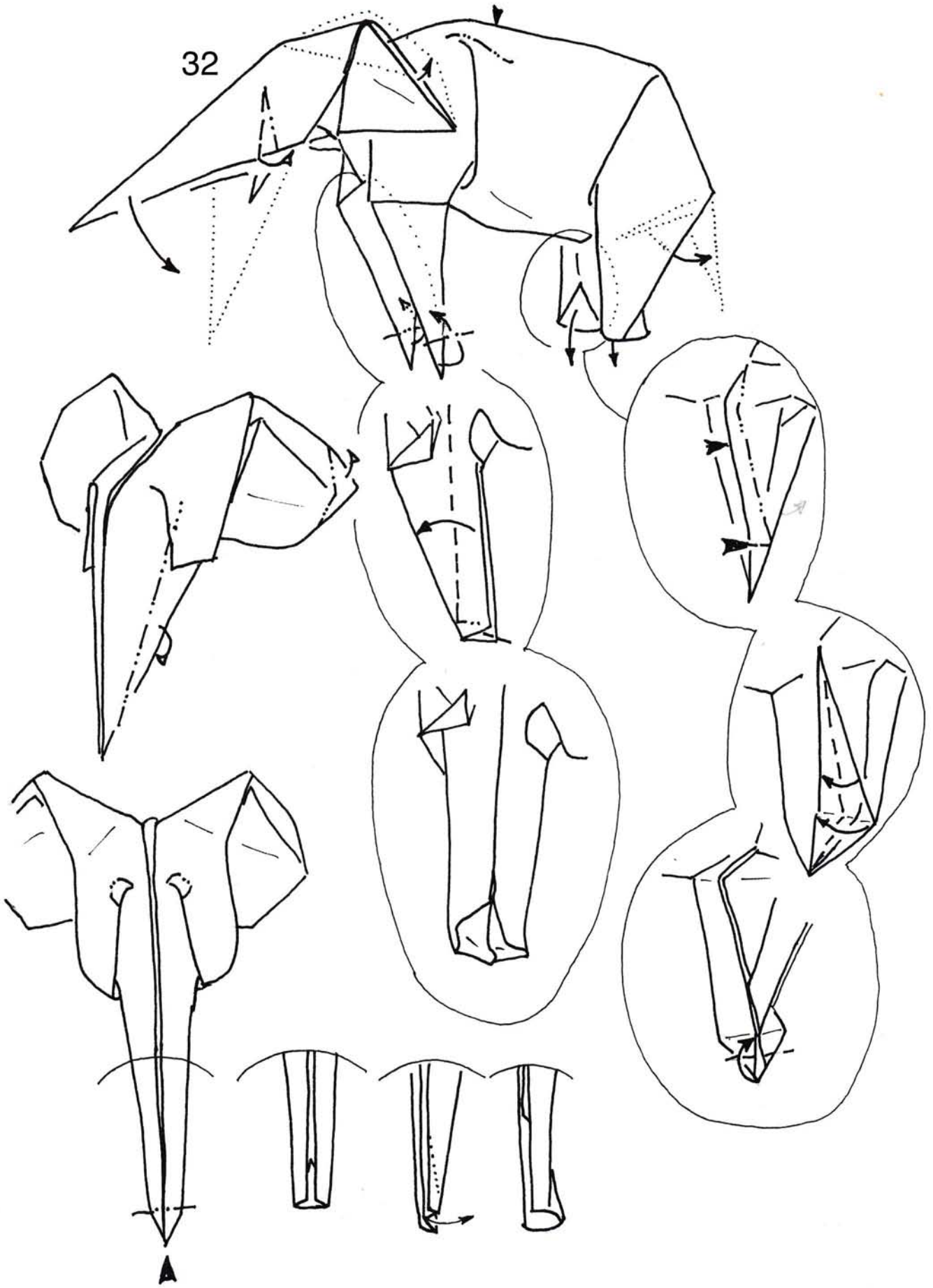

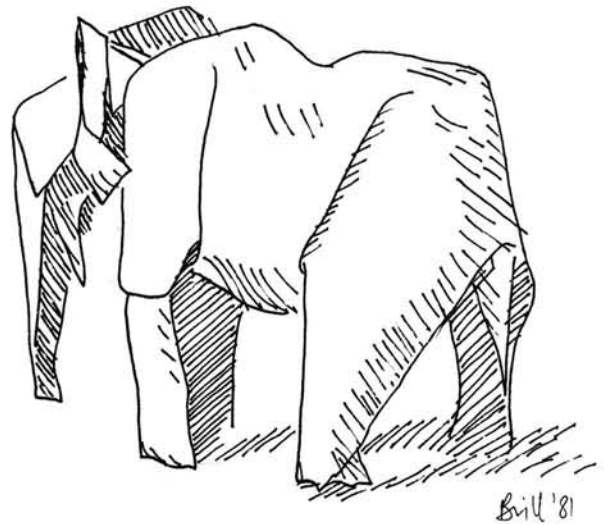
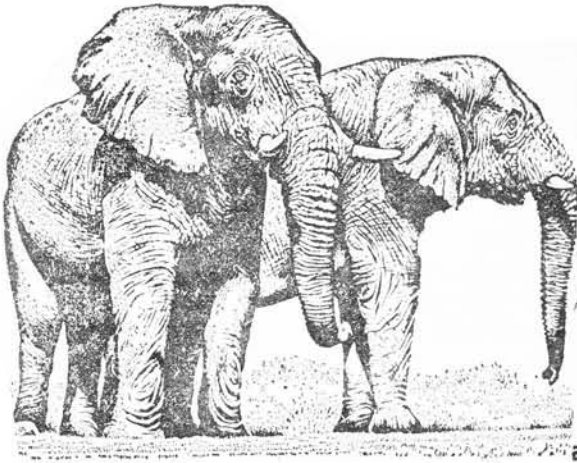

Bill '81

